

Idler Groups

The Widest Choice

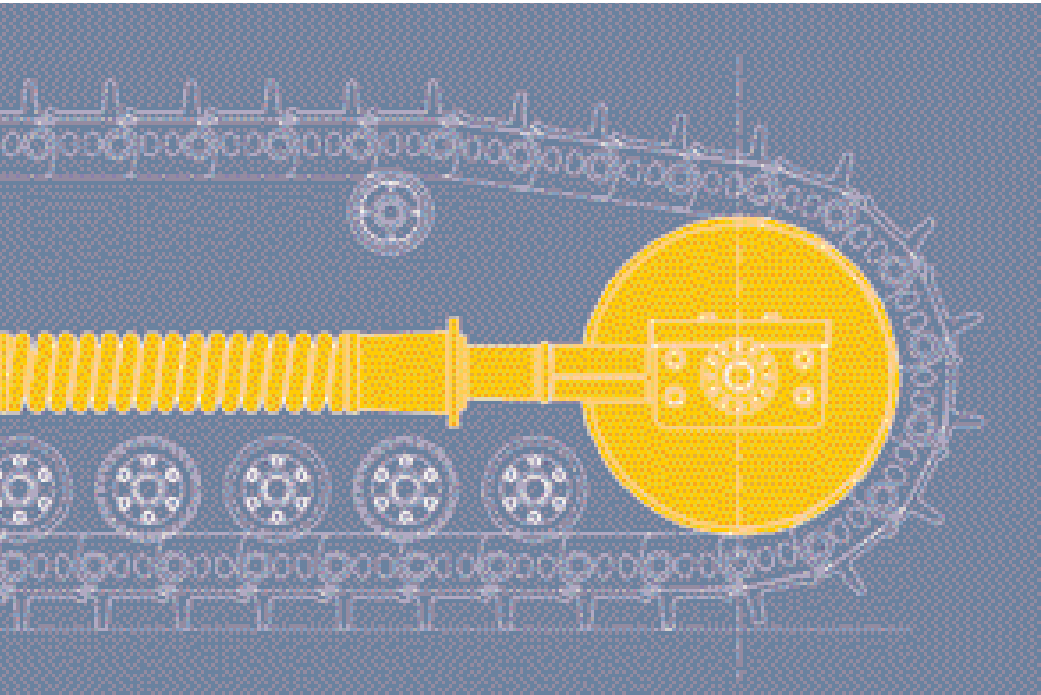

A Company of
ThyssenKrupp

BERCO S.p.A.



Berco

Moving Your Business Ahead

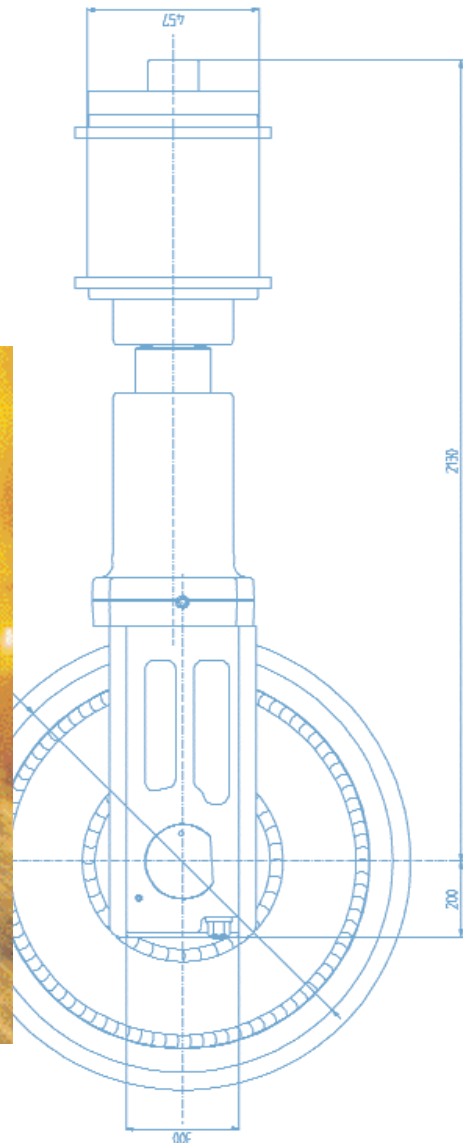
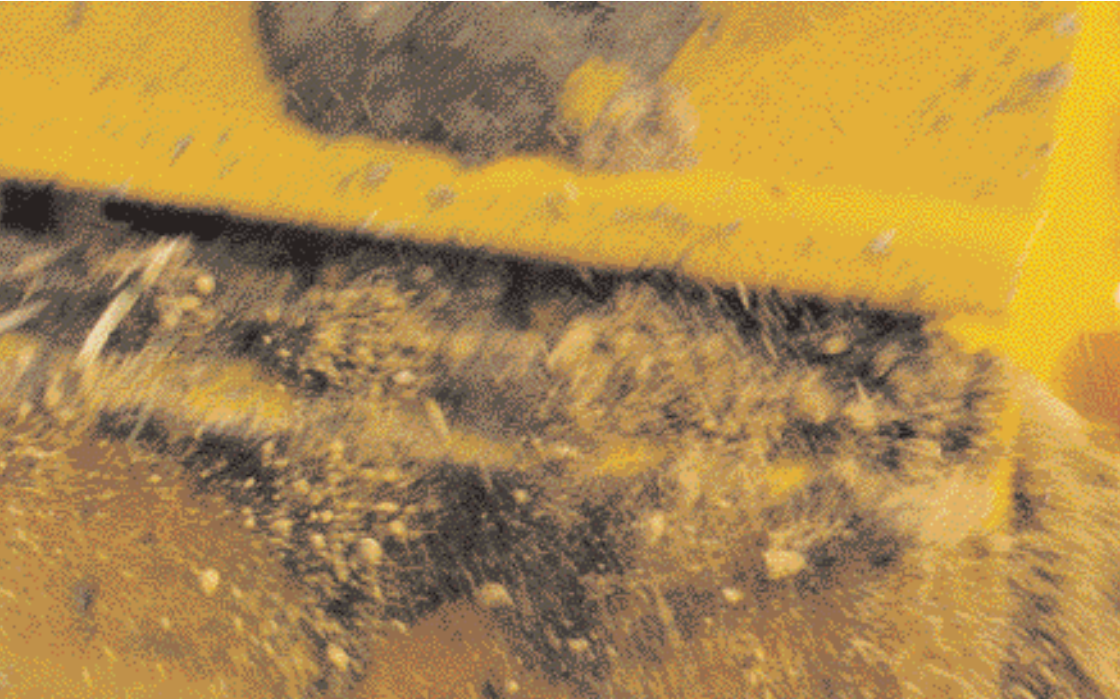

Leadership in Undercarriage

For about 90 years Berco's leadership and research has resulted in the greatest undercarriage value. Quality is the critical link that assures the maximum productivity of your machine. No one has invested more than Berco to assure dependable **High Quality Undercarriage**. Berco starts with the highest quality steel, then controls hardened depth along with other performance features. As a result Berco's undercarriage is second to none for extended wear life and value.

Getting the Most from your Undercarriage

Since 1920 Berco has continued to innovate and improve undercarriage performance. High-quality materials and careful manufacturing processes ensure that Berco undercarriage components are reliable, durable and wear at a predictable rate. Longer life and controllable wear mean that you get **maximum undercarriage performance** at the **lowest operating cost**. At Berco we call it "**Best Undercarriage Value**".

Berco Process Control

Berco builds value & durability into every undercarriage component. Berco controls processes critical to durability and value, such as: design, raw material, heat treating, manufacturing and because **Berco has control over these processes**, our undercarriages wear at a predictable rate and can be managed as a system.

Idler Groups

The Widest Choice

Berco Idler Groups

Berco track Idler Groups are manufactured for superior wear resistance. Whether cast, forged or fabricated, Berco idlers provide superior structural support and resurfacing capabilities. Special heat treatment ensures proper hardness level, providing long wear resistance. Berco's seals groups ensure lifetime lubrication eliminating idler maintenance and reducing operating costs. Berco offers the widest variety of idler groups to meet the requirements of your work environment.

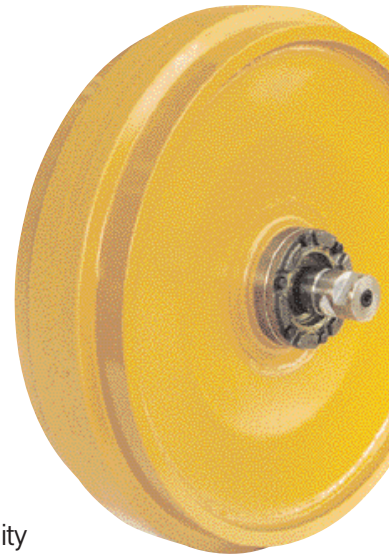
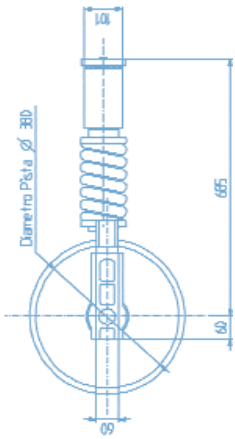

Your Best Undercarriage Value

- Low alloyed boron steels with certified hardenability based on Berco specification (for fabricated versions)
- Low alloyed cast steel (cast version)
- Heavy duty ring-rolled tread rims (for fabricated versions)
- Induction hardened tread diameter
- High tread surface hardness (HRC > 50) for reduced wear and longer life
- Tempered to resist cracking and chipping
- Precise design and manufacturing for proper fit
- Easy resurfacing
- Idlers can be supplied alone or fully assembled with brackets, adjuster and tension device
- The choice of the leading OEMs

The Widest Choice

- Cast, forged and fabricated (double or single flange) types
- Ultra low temperature (-50°C) version available
- More than 500 different configurations
- For track-type machines ranging from 1 to 400 ton
- The choice of the leading OEMs

Customer Satisfaction

Considering that more than 50% of your maintenance costs will go into maintaining the undercarriage, it is not surprising that Berco represents the best choice when the time comes for the replacement. And the best choice is confirmed by the large number of **Satisfied Customers** that **Keep Choosing Berco**

Idler Groups

Quality Components

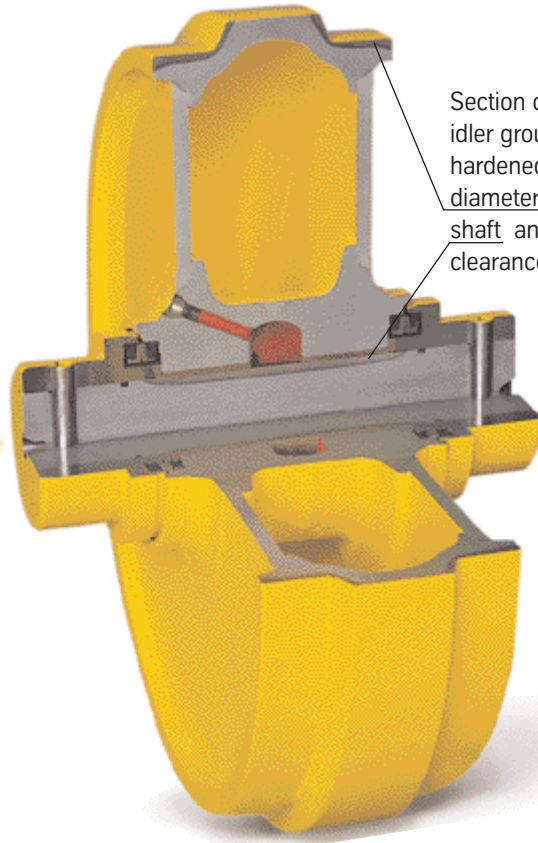

Section of a fabricated front idler group showing the hardened pattern of the tread diameter rim and of the shaft and the lubrication clearance.

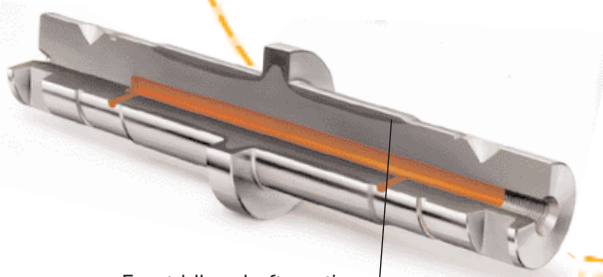

Front idler shaft section showing hardened areas and lubrication clearances.



Shafts, Bushings and Seal Groups.

All components are manufactured in fully automated production systems and computer controlled via Computer Manufacturing Technology systems (CIM). This guarantees a highly reliable processes ensuring consistent and excellent quality.

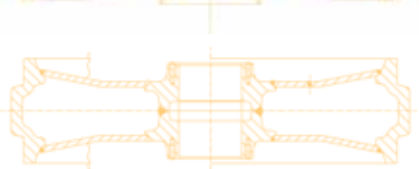

Adding Value to Our Products

Adding value to Your Business

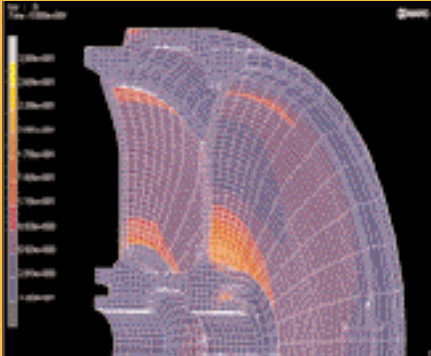

FEM analysis of an idler shell

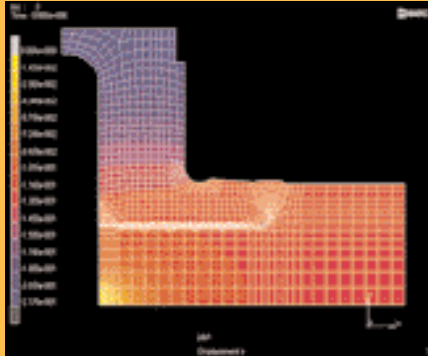

FEM analysis of a bracket

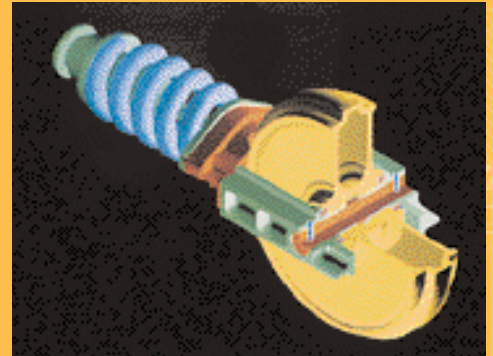

3D modeling of an idler group

Making a Superior Product

It all begins in the design stage, Berco **Research & Development** engineers employ state of the art computer design. The use of 3D modeling and finite element analysis (FEM) allow us to design and evaluate a component before it is built.

Our **Rapid Prototyping** enables Berco's engineers to optimize a design before spending money in tooling.

Berco **Metallurgy Laboratory** employs advanced machines such as an electron microscope with microanalysis, a spectrophotometer, tribometers for wear tests, MTS presses for static and fatigue tests on materials and components.

Photo-elasticity and **strain gauge** techniques are commonly used for stress and fatigue analysis on individual and assembled components.

Stress analysis at **extreme temperatures** (-70°C ÷ 250°C) are also carried out.

Reliability Test on components (ex. rollers) are carried out to determine life and performance in a variety of field applications.

Artificial Intelligence and **Vision** techniques are currently being developed to automatically inspect 100% of components. This reduces defects (ex. after forging or heat treatment) attributable to manufacturing to almost zero.

Huge efforts are also devoted to the development of **New Materials** and improvement of the **Heat Treating Processes**, to guarantee longer product life and **Superior Products**.

Having supplied leading OEMs for decades, **Berco's Engineers** and product specialists can help you design and manufacture the right undercarriage, using high tech software, tools and expertise. Berco can also help you reduce development and engineering time, tooling expenses and facility costs. **Berco Adds Value** not only to our products but also **to Your Business**.



Rapid prototyping



Electron microscope with microanalysis



Stress analysis at extreme temperatures

State of the Art Production

State of the Art Components



Ring rolling of tread rims

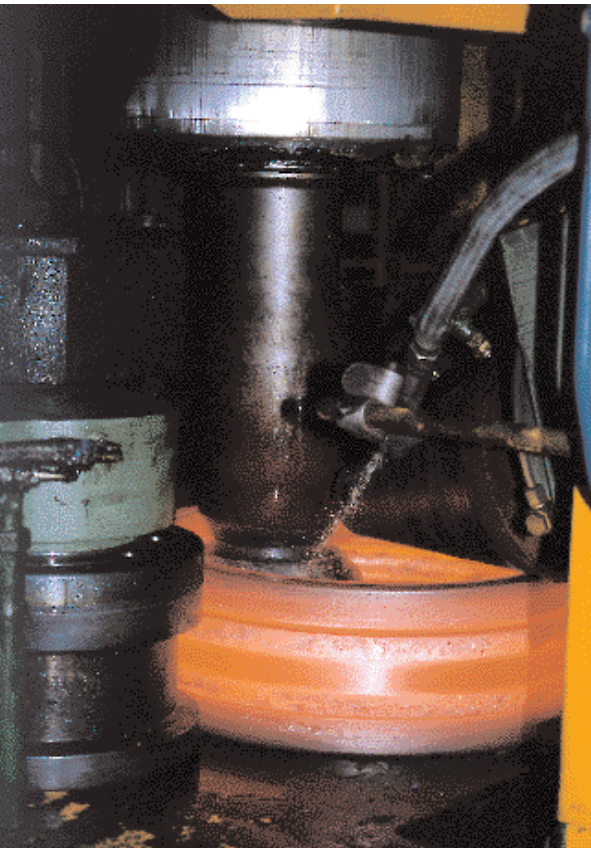

Ring rolling of tread rims



▲ Automated welding line

▼ Automated shaft manufacturing line



With a capacity of over **25,000 ton** of finished product the Berco Idler Department manufactures more than **130,000 Idler Groups** per year.

Fabricated Idlers: from the central raw material warehouse the steel bars are transferred to the induction heating/hot shearing and pre-forming stations and then to the multi-spindle ring rolling mill (Berco's design) where idler tread rims are produced in one operation. Rims are then machined and transferred to the FMS lines where they are welded by robots to the forged hubs and side plate(s). Induction hardening of the tread diameter follows and final assembly (with shaft, bushings and seals) in a fully automated FMS line complete the process.

Cast Idlers are machined in vertical lathes in the tread diameter and in the hub area. Induction hardening and final assembly followed by painting completes the process. Online control at each stage of manufacturing and final inspection of the finished product guarantees the **Total Quality** of all components.

Heat Treated to Treat You Even Better

Quality materials and state-of-art manufacturing are not enough to guarantee the quality of the finished products. That's why the heat treating of idlers is carried out with all process parameters (temperature gradients, time, quenching temperature, etc.) that are constantly monitored online. Hardening and tempering upgrade mechanical properties for superior wear resistance and excellent mechanical resistance for longer product life. Shafts are induction hardened and surface finished to guarantee longer bushing life and excellent mechanical properties.

Automated Processes Automatic Quality

The entire production process is fully automated and computer controlled via Computer Manufacturing Technology system. This guarantees highly reliable processes and constant quality of the products.

The Right Product at The Right Time

A vast variety of raw materials and flexible manufacturing give the competitive advantage of short lead times while matching your specific need.

That's what we also call Customer Satisfaction.

FMS line for automated assembly of Idler Groups



Induction hardening of shafts



We Care

Leadership in Environmental Development

Not only do **we care** about our **customers** supplying quality products manufactured under **ISO 9001** certified processes, but also **we care** about the **Environment**.

Since Jan 2000 Berco is **ISO 14001** certified and has adopted **Environmental Procedures** throughout the entire manufacturing process. We have an **Environmental Strategy** and we continuously check on the progress made toward the set Objectives.

Getting More out of Less.

Reduction of energy consumption, improved use of materials and minimization of waste, allows for a lower impact on the environment. We have given preference to environmentally friendly transportation like trains and boats and we have begun redesigning our packaging in order to use recyclable materials. We have changed our painting processes and now use environmentally friendly water-based paint, with a reduction in the amount of pollutant emissions. We have adopted a closed loop cooling system that reuses the water from our heat treatment processes instead of emitting it into the environment.

Customer Service

We have a large dealer network covering 70 countries in the world. They have been in business for decades, they know the business and they know it from their customers' point of view. They understand **customers' needs** and they know that their success is tied to their customers' successes.

We **support** our dealers with our professional sales force. We train them, we provide them with the right marketing tools and advanced technological systems. We have developed a computer based integrated system **BOPIS** (Berco Online Product Information System) enabling a dealer technician to use a laptop computer from the field to consult our database and easily find the right answer.

We back you, wherever you are. We work with our dealers to establish a parts and service presence near you, in order to always have the right product at the right time in the right place. It is customer satisfaction that has built our **Berco Track Record**.

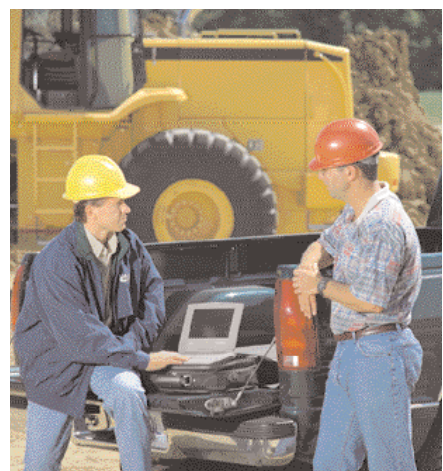
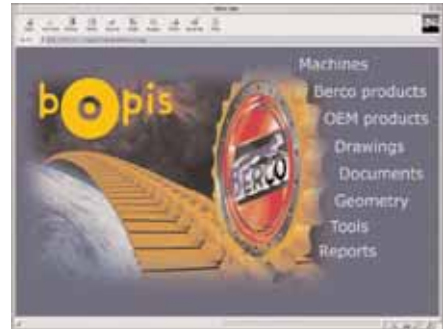

01003.WR412GB00C

Published by Berco Communication Dept.

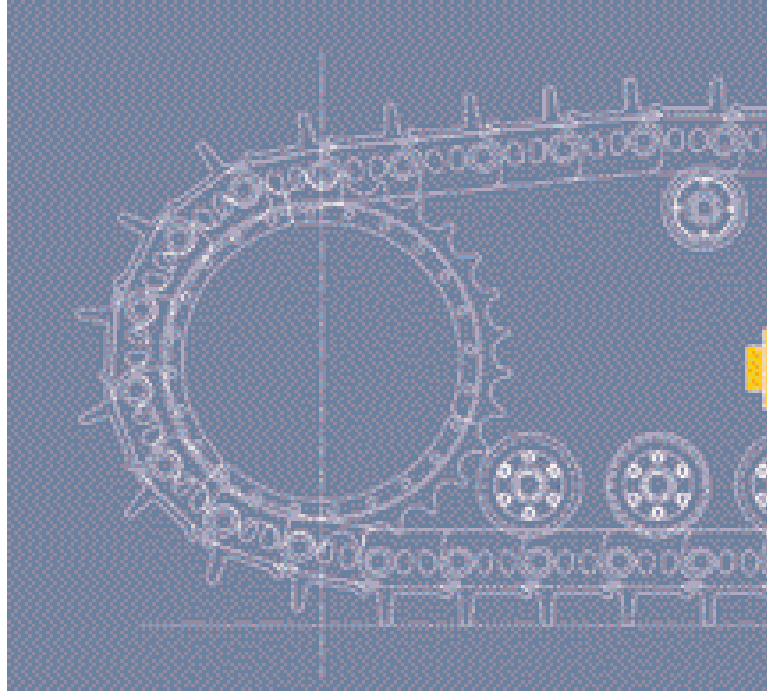

All manufacturers's names, numbers, symbols and descriptions are used for reference purposes only.
All parts listed are of Berco original production.
The specifications and processes described in this brochure are subject to change without notice

BERCO S.p.A.
Via 1° Maggio, 237
44034 Copparo (Ferrara) Italy
Phone +39 0532 864 111
Fax +39 0532 864 259
www.berco.com
info@berco.com

Your Berco dealer: